

TROUBLESHOOTING

LED lights do not illuminate on charger

Check the charging adaptor is securely plugged into the wall outlet. Check the battery is firmly connected to the charging cradle. Check that the charging jack is securely connected to the charging cradle.

The battery has a short run time

Ensure the battery is properly charged. It will take 4-5 charging cycles before the battery reaches optimum charge and run time. On the initial charge, the battery requires 5 hours of charging. Subsequent charging only requires 3-5 hours.

Variable speed trigger is locked

Ensure that the forward / reverse lever is in the correct position; pressed left for forwards direction, pressed right for backwards direction. If it is in between the two settings the variable speed trigger will be locked.

The Brushless Impact Wrench is stripping the bolt head

Ensure the correct size socket is being used and placed over the bolt head securely before attempting to fasten or loosen.

MAINTENANCE

WARNING! ALWAYS ENSURE THE TOOL HAS COMPLETELY STOPPED AND THE BATTERY IS REMOVED PRIOR TO ANY MAINTENANCE.

- After each use, blow air through the tool housing to ensure it is free from all dust, dirt, etc. Build up of dust, dirt particles may cause the tool to overheat and shorten the life of the tool.
- If the housing of the impact wrench requires cleaning, do not use solvents but a moist soft cloth or soft brush only.
- Never let any liquid get inside the tool, never immerse any part of the tool into liquid.
- When not in use, the impact wrench should be stored in a dry, frost free location not within the reach of children.

Note: Ozito Industries will not be responsible for any damage or injuries caused by the repair of the impact wrench by an unauthorised person or by mishandling of the impact wrench.

DESCRIPTION OF SYMBOLS

Danger! Read the operating instructions to reduce the risk of injury.

Caution! Wear ear-muffs. The impact of noise can cause damage to hearing.

Caution! Wear a breathing mask. Dust which is injurious to health can be generated when working on wood and other materials. Never use the device to work on any materials containing asbestos!

Caution! Wear safety goggles. Sparks generated during working or splinters, chips and dust emitted by the device can cause loss of sight.

Double insulated

SOUND & VIBRATION

Sound and vibration values were measured in accordance with EN 60745.

L _{WA} sound pressure level:	72.27 dB
K ₁ uncertainty:	3 dB
L _{WA} sound power level:	83.27 dB
K ₂ uncertainty:	3 dB

Wear ear-muffs.

The impact of noise can cause damage to hearing.

Total vibration values (vector sum of three directions) determined in accordance with EN 60745.

Tightening screws and nuts of maximum permitted size	
Vibration emission value a ₁ :	4.027m/s ²
K uncertainty:	1.5m/s ²

Keep the noise emissions and vibrations to a minimum.

- Only use appliances which are in perfect working order.
- Service and clean the appliance regularly.
- Adapt your working style to suit the appliance.
- Do not overload the appliance.
- Have the appliance serviced whenever necessary.
- Switch the appliance off when it is not in use.
- Wear protective gloves.



For EU countries only

Never place any electric power tools in your household refuse.

To comply with European Directive 2012/19/EC concerning old electric and electronic equipment and its implementation in national laws, old electric power tools have to be separated from other waste and disposed of in an environment-friendly fashion, e.g. by taking to a recycling depot.

Recycling alternative to the return request:

As an alternative to returning the equipment to the manufacturer, the owner of the electrical equipment must make sure that the equipment is properly disposed of if he no longer wants to keep the equipment. The old equipment can be returned to a suitable collection point that will dispose of the equipment in accordance with the national recycling and waste disposal regulations. This does not apply to any accessories or aids without electrical components supplied with the old equipment.

The reprinting or reproduction by any other means, in whole or in part, of documentation and papers accompanying products is permitted only with the express consent of the ISC GmbH.

Subject to technical changes

DECLARATION OF CONFORMITY

ISC GmbH · Eschenstraße 6 · D-94405 Landau/Isar		EU
explains the following conformity according to EU directives and norms for the following product		
Brushless Impact Wrench PXBWS-340U (Ozito)		
<input type="checkbox"/> 2014/29/EU	<input checked="" type="checkbox"/> 2006/42/EC	<input type="checkbox"/> Annex IV
<input checked="" type="checkbox"/> 2005/32/EC_2009/1125/EC		Notified Body:
<input type="checkbox"/> 2014/35/EU		Reg. No.:
<input type="checkbox"/> 2006/28/EC	<input type="checkbox"/> 2000/14/EC_2005/68/EC	<input type="checkbox"/> Annex VI
<input checked="" type="checkbox"/> 2014/30/EU		Notified Body:
<input checked="" type="checkbox"/> 2014/32/EU		Reg. No.:
<input type="checkbox"/> 2014/53/EC		Annex VI
<input type="checkbox"/> 2014/68/EU		Noise: measured L _{WA} = dB (A); guaranteed L _{WA} = dB (A)
<input type="checkbox"/> EU/2016/426		P = kW; L ₁₀ = cm
<input type="checkbox"/> EU/2016/425		Notified Body:
<input checked="" type="checkbox"/> 2011/65/EU	<input type="checkbox"/> 2012/46/EU	Emission No.:
Standard references: EN 60745-1; EN 60745-2-2; EN 55014-1; EN 55014-2; EN 61000-3-2; EN 61000-3-3		
Landau/Isar, den 24.04.2018		
First CE: 18	Art.-No.: 30.003.19	I.-No.: 11017
Subject to change without notice		
	Archive-File/Record: NAPFD18339	Documents registrar: Alex Kurz
		Wiesenweg 22, D-94405 Landau/Isar

ELECTRICAL SAFETY

WARNING! When using mains-powered tools, basic safety precautions, including the following, should always be followed to reduce risk of fire, electric shock, personal injury and material damage. Read the whole manual carefully and make sure you know how to switch the tool off in an emergency, before operating the tool. Save these instructions and other documents supplied with this tool for future reference. Before you connect the charger to the mains supply make sure that the data on the rating plate are identical to the mains data.

This tools charger is double insulated, therefore no earth wire is required.

If the supply cord is damaged, it must be replaced by an electrician or a power tool repairer in order to avoid a hazard. **Note:** Double insulation does not take the place of normal safety precautions when operating this tool. The insulation system is for added protection against injury resulting from a possible electrical insulation failure within the tool. The power supply for this products charger should be protected by a residual current device (rated at 30mA or less). A residual current device reduces the risk of electric shock.

GENERAL POWER TOOL SAFETY WARNINGS

DANGER! Read all safety regulations and instructions. Any errors made in following the safety regulations and instructions may result in an electric shock, fire and/or serious injury. **Keep all safety regulations and instructions in a safe place for future use.** The term "electric tool" used in the safety instructions refers to electric tools operated from the mains power supply (with a power cable) and to battery operated electric tools (without a power cable).

- Workplace safety
 - Keep your work area clean and well illuminated. Untidy or unlit work areas can result in accidents.
 - Do not operate the electric tool in an environment where there is a risk of explosions and where there are inflammable liquids, gases or dust. Electric tools produce sparks which could set the dust or vapours alight.
 - Keep the electric tool out of the reach of children and other persons. If there is a distraction, you may lose control of the appliance.

- Electrical safety
 - The connector plug from this electric tool must fit into the socket. The plug should never be altered in any way. Never use adapter plugs together with earthed electric tools. Unaltered plugs and correct sockets reduce the risk of an electric shock.
 - Avoid bodily contact with earthed surfaces such as pipes, heating, ovens and fridges. The risk of electric shock is increased if your body is earthed.
 - Keep the tool out of the rain and away from moisture. The ingress of water into an electric tool increases the risk of an electric shock.
 - Do not use the cable to carry the electric tool, to hang it up or to pull it out of the socket. Keep the cable away from heat, oil, sharp edges and moving parts of the appliance. Damaged or entangled cables increase the risk of an electric shock.
 - If you are working outdoors with an electric tool, only use extension cables which are designed specifically for this purpose. Using specially designed outdoor extension cables, the risk of electric shock is reduced.
 - If operation of the electric tool in a damp environment can not be avoided, use a earth-leakage circuit-breaker. The earthleakage circuit breaker reduces the risk of an electric shock.

- Safety of persons
 - Be careful, watch what you are doing and use an electric tool sensibly. Do not use the tool if you are tired or under the influence of drugs, alcohol or medication. A moment of inattention when using the electric tool can result in serious injuries.
 - Wear personal protection equipment and always wear safety goggles. Wearing personal protection (such as dust masks, non-slip safety shoes, safety helmet or ear protection, depending upon the type and use of the electric tool) reduces the risk of injury.
 - Make sure that the appliance cannot start up accidentally. Ensure that the electric tool is switched off before you connect it to the power supply and/or insert the battery, or pick up or carry the tool. If your finger is on the switch whilst carrying the electric tool or if you connect the appliance to the mains when it is switched on, this can lead to accidents.
 - Remove keys and wrenches before switching on the electric tool. A tool or key which comes into contact with rotating parts of the appliance can lead to injuries.
 - Avoid abnormal working postures. Make sure you stand squarely and keep your balance at all times. In this way, you can control the electric tool better in unexpected circumstances.
 - Wear suitable work clothes. Do not wear loose clothing or jewellery. Keep hair, clothes and gloves away from moving parts. Loose clothing, jewellery or long hair can get trapped in moving parts.
 - If vacuuming devices and draining devices can be fitted, make sure that these are correctly attached and correctly used. The use of a dust extraction system can reduce the danger posed by dust.

BRUSHLESS IMPACT WRENCH SAFETY WARNINGS

WARNING! Wear ear protectors when impact drilling. Exposure to noise can cause hearing loss. Use auxiliary handle(s), if supplied with the tool. Loss of control can cause personal injury.

Hold power tool by insulated gripping surfaces, when performing an operation where the cutting accessory may contact hidden wiring or its own cord. Cutting accessory contacting a "live" wire may make exposed metal parts of the power tool "live" and could give the operator an electric shock.

Before drilling into walls, ceilings etc, ensure that there are no concealed power cables or pipes in the cavity.

Bits, sockets and tools get hot during operation, it's recommended to wear gloves when handling them. Do not overreach while operating the tool. Maintain a balanced working stance at all times.

Do not use this tool for prolonged periods of time. Take regular breaks. Use gloves to provide extra cushioning in order to avoid any injury from the vibrations of the tool.

Always use safety glasses. Everyday glasses are not Safety Glasses.

WARNING! Some dust created by power sanding, sawing, grinding, drilling and other construction activities contain chemicals known to cause cancer, birth defects or other reproductive harm.

Some examples of these chemicals are:

- Lead from lead-based paints
- Crystalline silica from bricks and cement and other masonry products
- Arsenic and chromium from chemically treated timber

Your risk from exposure to these chemicals varies, depending on how often you do this type of work. To reduce your exposure to these chemicals: work in a well ventilated area and work with approved safety equipment, such as dust masks that are specially designed to filter out microscopic particles.

WARNING! This appliance is not intended for use by young or infirm persons unless supervised by a responsible person to ensure that they can use the appliance safely. Young children should be supervised to ensure that they do not play with the appliance.



18V LITHIUM ION

BRUSHLESS IMPACT WRENCH

ORIGINAL INSTRUCTIONS

SPECIFICATIONS

Voltage:	18V
No Load Speed:	0-2900/min
Drive Shaft:	12.7mm (1/2")
Impact Rate:	0-3000/min
Max. Torque:	215Nm
Tool Weight:	1.2kg

ozito-diy.co.uk

5 YEAR REPLACEMENT WARRANTY

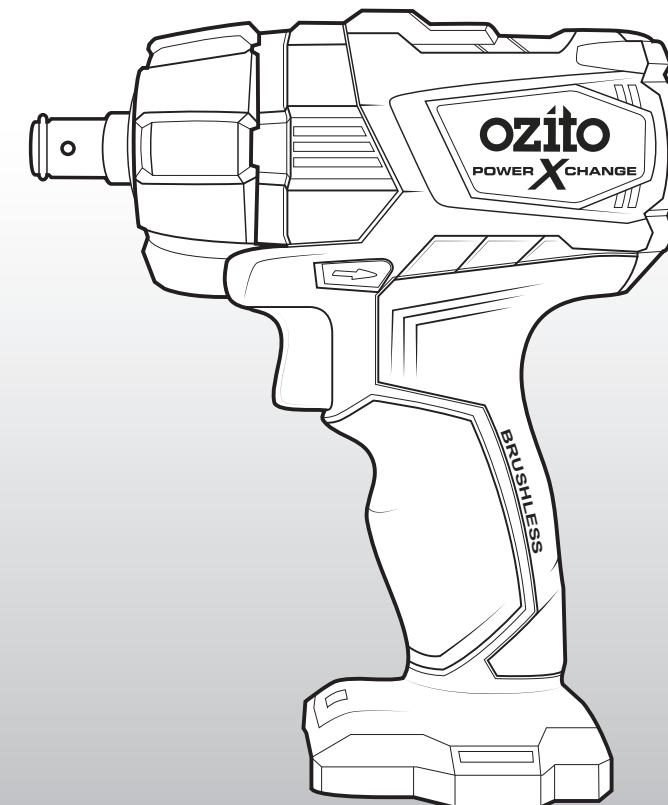

STANDARD EQUIPMENT

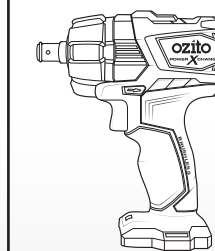

Brushless Impact Wrench

PXBWS-340U

Art.-No.: 30.003.19

I.-No.: 11017

WARRANTY

All of our products undergo strict quality checks to ensure that they reach you in perfect condition. In the unlikely event that your device develops a fault, please contact our service department at the address shown on this guarantee card. You can also contact us by telephone using the customer service number shown. Please note the following terms under which guarantee claims can be made:

1. These warranty terms regulate additional warranty services, which the manufacturer mentioned below promises to buyers of its new products in addition to their statutory guarantee claims are not affected by this guarantee. Our guarantee is free of charge to you.

2. The warranty services only covers defects due to material or manufacturing faults on a product which you have bought from the manufacturer mentioned below are limited to either the rectification of said defects on the product or the replacement of the product, whichever we prefer. Please note that our devices are not designed for use in commercial, trade or professional applications. A guarantee contract will not be created if the device has been used by commercial, trade or industrial business or has been exposed to similar stresses during the guarantee period.

3. The following are not covered by our guarantee:
- Damage to the device caused by a failure to follow the assembly instructions or due to incorrect installation, a failure to follow the operating instructions (for example connecting it to an incorrect mains voltage or current type) or a failure to follow the maintenance and safety instructions or by exposing the device to abnormal environmental conditions or by lack of care and maintenance.
- Damage to the device caused by abuse or incorrect use (for example overloading the device or the use of unapproved tools or accessories), ingress of foreign bodies into the device (such as sand, stones or dust, transport damage), the use of force or damage caused by external forces (for example by dropping it).
- Damage to the device or parts of the device caused by normal or natural wear or tear or by normal use of the device.

4. Your Product is guaranteed for a period of 60 months from the original date of purchase and is intended for DIY (Do It Yourself) use only. Lithium Ion batteries and chargers are

covered by a 12 month warranty. Warranty excludes consumable parts. Guarantee claims should be submitted before the end of the guarantee period within two weeks of the defect being noticed. No guarantee claims will be accepted after the end of the guarantee period. The original guarantee period remains applicable to the device even if repairs are carried out or parts are replaced. In such cases, the work performed or parts fitted will not result in an extension of the guarantee period, and no new guarantee will become active for the work performed or parts fitted. This also applies if an on-site service is used.

IN ORDER TO MAKE A CLAIM UNDER THIS WARRANTY YOU MUST RETURN THE PRODUCT TO THE PLACE OF PURCHASE WITH YOUR REGISTER RECEIPT.

Please refer to the restrictions of this warranty concerning wearing parts, consumables and missing parts as set out in the service information in these operating instructions.

CUSTOMER SERVICE HELPLINE

GB: 0151 294 4488

IRL: 1850 882711

Ozito-diy.co.uk

KNOW YOUR PRODUCT

BRUSHLESS IMPACT WRENCH

- 1 1/2" Drive Shaft
- 2 Tri-Beam LED Light
- 3 Variable Speed Trigger
- 4 Battery Seating
- 5 Forward/Reverse Lever

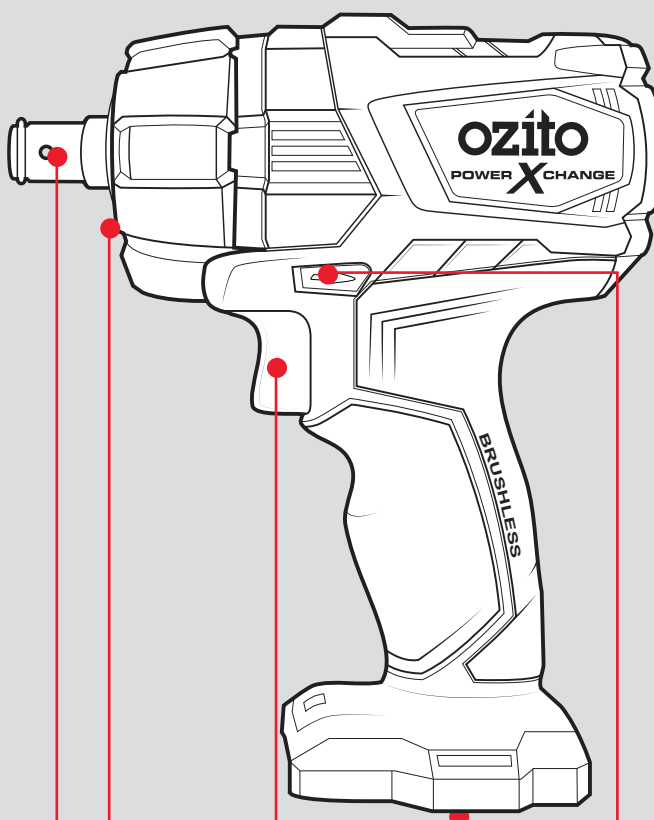

- 1
- 2
- 3
- 4
- 5

ONLINE MANUAL

Scan this QR Code with your mobile device to take you to the online manual.



SETUP & PREPARATION

1. BEFORE USE

Items Supplied

Please check that the article is complete as specified in the scope of delivery. If parts are missing, please contact our service centre or the sales outlet where you made your purchase at the latest within 5 working days after purchasing the product and upon presentation of a valid bill of purchase. Also, refer to the warranty table in the service information at the end of the operating instructions.

- Open the packaging and take out the equipment with care.
- Remove the packaging material and any packaging and/or transportation braces (if available).
- Check to see if all items are supplied.
- Inspect the equipment and accessories for transport damage.
- If possible, please keep the packaging until the end of the guarantee period.

Danger!

The equipment and packaging material are not toys. Do not let children play with plastic bags, foils or small parts. There is a danger of swallowing or suffocating!

Proper Use

This equipment is suitable for loosening and tightening screws and nuts.

The equipment can be operated from the mains power supply using the power cable or alternatively in battery-powered mode using a suitable rechargeable battery.

The equipment is to be used only for its prescribed purpose. Any other use is deemed to be a case of misuse. The user / operator and not the manufacturer will be liable for any damage or injuries of any kind as a result of this.

Please note that our equipment has not been designed for use in commercial, trade or industrial businesses or for equivalent purposes.

Caution!

Residual risks

Even if you use this electric power tool in accordance with instructions, certain residual risks cannot be ruled out. The following hazards may arise in connection with the equipment's construction and layout:

1. Lung damage if no suitable protective dust mask is used.
2. Damage to hearing if no suitable ear protection is used.
3. Health damage caused by hand-arm vibrations if the equipment is used over a prolonged period or is not properly guided and maintained.

2. ASSEMBLY

WARNING! ENSURE THE TOOL IS SWITCHED OFF AND THE BATTERY IS REMOVED BEFORE PERFORMING ANY OF THE FOLLOWING TASKS.

Inserting & Removing Accessories

- 1 Align an appropriate 1/2" socket with the drive shaft.
- 2 Push the socket onto the shaft until it clicks into place.

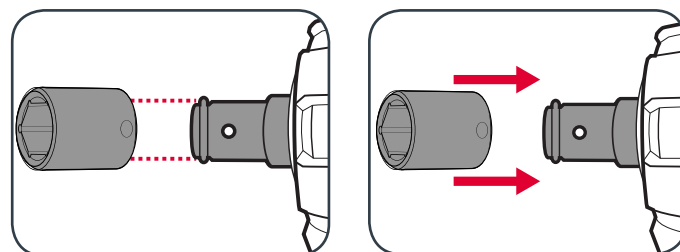

- 3 Pull the accessory away from the drive shaft to remove.

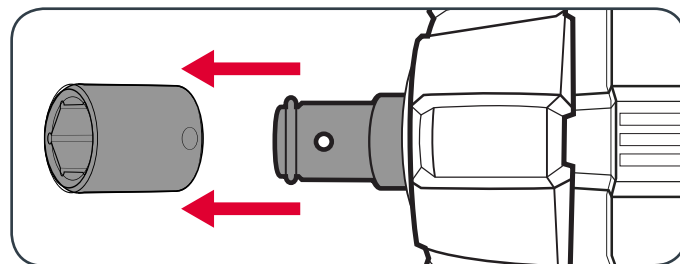

CAUTION! DO NOT HANDLE ACCESSORIES WITHOUT GLOVES AS THEY ARE SHARP AND CAN BECOME HOT AFTER USE, POTENTIALLY CAUSING PERSONAL INJURY.

OPERATION

3. BATTERY FITMENT

Inserting & Removing the Battery

- 1 Align the ribs of the battery with the recess at the base of the wrench handle and push in until it clicks into place.

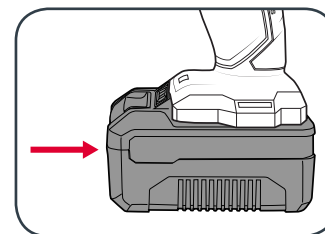

- 2 To remove, press and hold the battery release tab and then slide out.

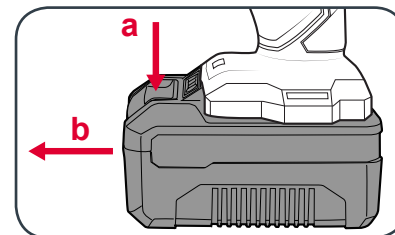

Battery protection system

The tool is equipped with the battery protection system, which helps to ensure a long service life.

The output power automatically cuts off during operation when the tool and/or battery are placed under the following situations:

- **When the tool is overloaded:**
If this occurs, release the trigger switch and remove causes of overload, then pull the switch trigger again to restart.
- **When the remaining battery capacity becomes low:**
Recharge the battery pack.

4. CONTROLS

Variable Speed Trigger

- 1 To start the wrench, squeeze the variable speed trigger.
- 2 Release the variable speed trigger to stop the wrench.

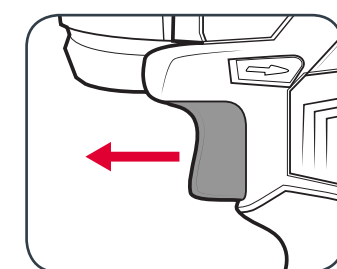
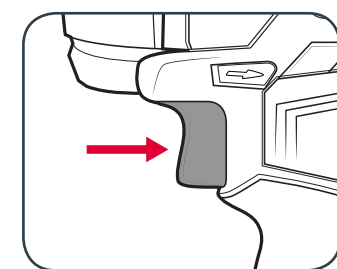

- 3 Control the speed by adjusting the amount of pressure applied to the trigger.

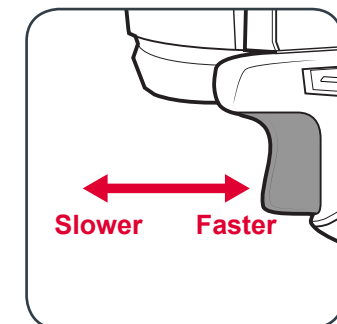

Forward/Reverse Lever

- 1 To drive screws and bolts, push the fwd/rev lever hard left.
- 2 To remove screws and bolts, push the fwd/rev lever hard right.

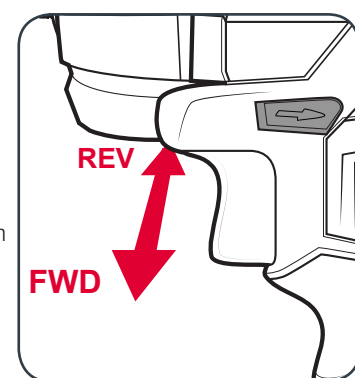

5. DRIVING PROCEDURE

- 1 Depress and release the on/off trigger to ensure it is not locked.
- 2 Check the forward/reverse lever is on desired setting.

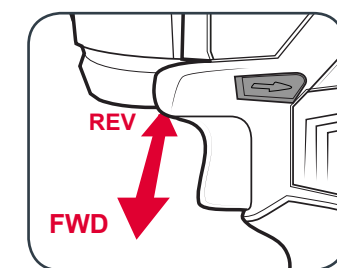
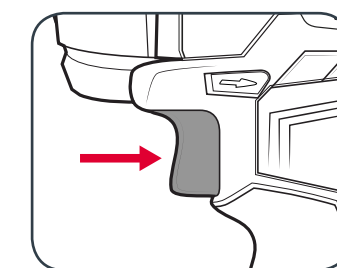

- 3 Ensure the work piece is secured to stop it turning whilst driving.

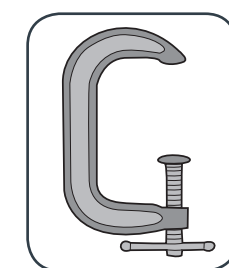

- 4 Hold the socket firmly against the bolt to stop it slipping.

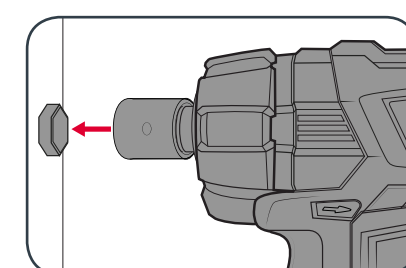

- 5 Slowly increase pressure on trigger to appropriate torque for circumstances until bolt is tightened.

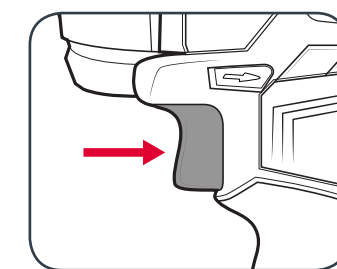

6. WORKING WITH THE IMPACT WRENCH

Loosening:

- Mount a drive socket insert on the impact driver
- Place the impact driver on the screw/nut and loosen the screw/nut by pressing the On/Off switch.
- If the screws/nuts are very tight or if they are rusted, use a tire wrench or torque wrench to slightly loosen them.

Tightening:

- **Warning!** When tightening screws/nuts, avoid excessive impact to help prevent damaging the fasteners or workpiece. Be particularly careful when impacting smaller fasteners because they require less impacting torque.
- The proper fastening torque may differ depending upon the kind or size of the bolt. Always check the torque with a torque wrench.