

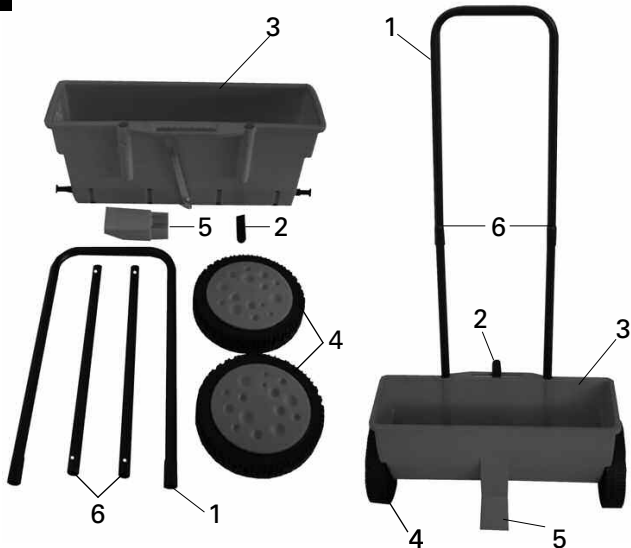

Lawn Spreader Instructions

Setup Guide:

1



Layout

1. Push bar
2. Adjustment lever for setting the spreading volume
3. Spreader tank
4. Wheel
5. Stand
6. Push rods

Step 1: Push Bar

- Fit the push rods into the spreader tank (Fig.2)
- Fit the push bar on to the push rods (Fig.3)

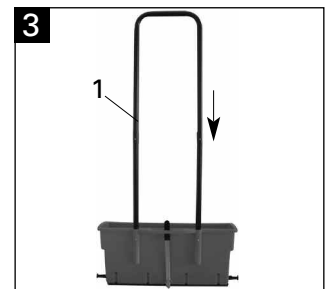
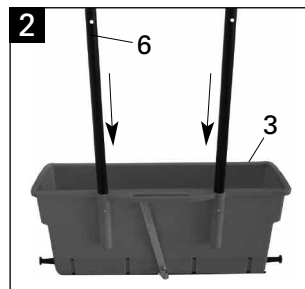

Step 2: Adjustment lever

- Fit the adjustment lever grip (Fig.1/ Item 2) to the adjustment lever (Fig.4/ Item A).

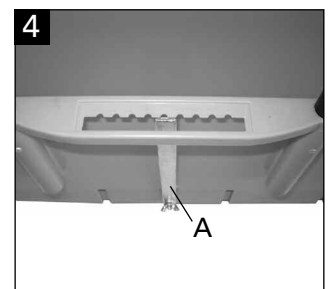

Step 3: Foot

- Remove the screw (Fig.5/ Item B)
- Insert the foot (Fig.6/ Item 5) and secure it.

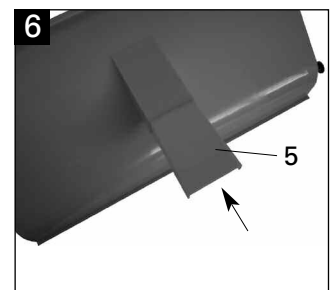
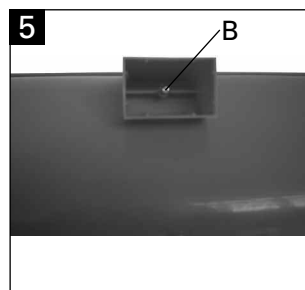

Step 4: Wheels

- Take the wheel caps off the wheels (Fig.7)
- Remove the screws (Fig.8/ Item E) (on both sides).
- Attach the wheels (Fig.9/ Item D) and secure them.
- Fit the wheel caps.

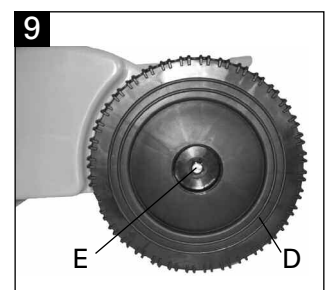
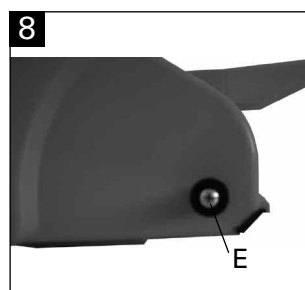
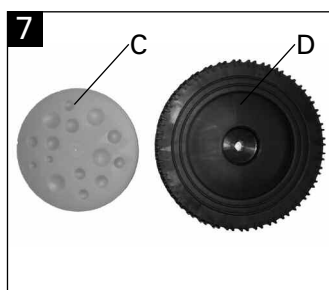



Guide To Using Lawn Spreader

Application Advice

To get the best results from your Lawn Spreader read all instructions and advice before use

1. MEASURE YOUR LAWN AREA

Measure the length and breadth of the lawn. Multiply the measurements together to get the area you need to treat (For example 10 metres x 10 metres = 100m²).

2. PREPARING YOUR SPREADER FOR USE

- Always read the product label before use.
- DO NOT fill the Lawn Spreader on the lawn.
- Ensure hopper is dry and applicator outlets are clear of obstruction.
- Set the distribution lever to zero.
- Carefully pour product into Lawn Spreader ensuring an even spread across the hopper.
- To ensure that the Lawn Spreader distributes the lawn treatment product at the recommended rate it is essential that the hopper is filled above the black plastic plate at all times.
- DO NOT apply if grass is wet/damp and longer than 60-70mm as lawn treatment product may become damp, blocking the Lawn Spreader and may result in over or under-dosing of product.

3. USING YOUR SPREADER

1. Before inserting the appropriate Westland lawn product, always set the adjustable lever to zero.
2. Do not fill the spreader on the lawn. Place the spreader on a sheet of newspaper or plastic to avoid spillage on paths/patios.
3. Set calibration lever on top of the hopper to appropriate setting to start applying the product. It is important to start walking immediately after the lever is set as the product will start discharging from the spreader. The recommended settings for Westland product with an application rate of 35g/m²
0 =Off
3 =Aftercut Lawn Feed & Conditioner, Lawn Feed Weed Moss Killer*, Autumn Lawn Feed & Moss Killer**
4. It is recommended to treat 2/3 stripes of lawn alongside fences and hedges to avoid having to make difficult manoeuvres along these perimeters. This will allow you to treat the rest of the lawn in stripes (Fig.1).
5. Walk at a steady pace up and down the lawn, slightly overlapping the edges to prevent stripes until you have covered the required distance (Fig.2).
6. If rain does not fall within 48 hours, it is best to water the lawn thoroughly.
7. The lawn is safe for use by children and pets once the product has been watered in.

Fig.1

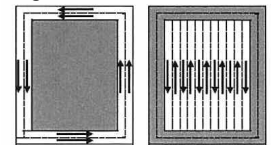

Complete two circuits of the lawn. Continue treating remaining lawn in straight stripes off the longest side.

Fig.2

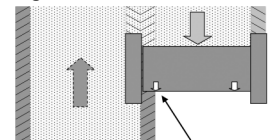

For correct bout spacing line up arrow on hopper with previous wheeling mark.

4. AFTER USE

- NEVER leave product sitting in the hopper. Move the spreader off the lawn and pour leftover product back into the original container, seal tightly and store in a safe, dry place.
- Clean hopper thoroughly using a stiff bristled brush. Open the distribution lever to setting 10 and remove all residues, particularly around the axle.
- DO NOT allow any cleanings to enter drains. Clean up residues and dispose of safely.
- Store the clean, dry Lawn Spreader under cover ready for next use.



*Westland Lawn Feed Weed & Moss Killer MAPP 10794 contains 2,4-D, mecoprop-P and ferrous sulphate.

**Westland Autumn Lawn Feed & Moss Killer MAPP 11023 contains ferrous sulphate. Always read the label. Use pesticides safely.