

Original operating instructions
Dirty Water Pump

Einhell[®]

1

Art.-Nr.: 41.706.12

I.-Nr.: 11010

RG-DP **7525 N**



☞ Read and follow the operating instructions and safety information before using for the first time.

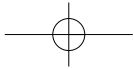
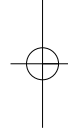
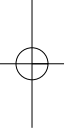

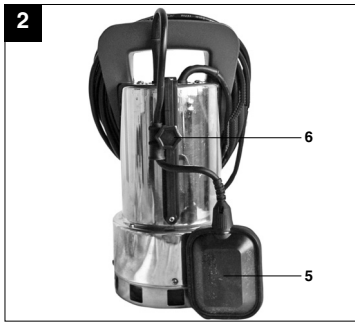

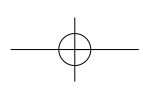
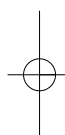
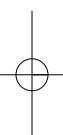
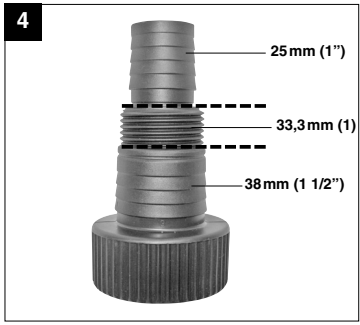

⚠ Important!

When using equipment, a few safety precautions must be observed to avoid injuries and damage. Please read the complete operating manual with due care. Keep this manual in a safe place, so that the information is available at all times. If you give the equipment to any other person, give them these operating instructions as well.

We accept no liability for damage or accidents which arise due to non-observance of these instructions and the safety information.

1. Safety regulations**⚠ Caution!**

In stagnant water bodies, garden ponds, dams and their surrounding areas the unit may only be used with an earth-leakage circuit breaker with an actuating rated current of up to 30 mA (according to VDE 0100 Part 702 and 738).

The equipment is not designed for use in swimming pools and paddling pools of any kind or other bodies of water in which people or animals may be present during operation. It is prohibited to operate the equipment if a person or animal is in the danger area. Ask your electrician!

This equipment is not designed to be used by people (including children) with limited physical, sensory or mental capacities or those with no experience and/or knowledge unless they are supervised by a person who is responsible for their safety or they have received instructions from such a person in how to use the equipment safely. Children must always be supervised in order to ensure that they do not play with the equipment.

Important!

- Before you put the equipment into operation, arrange for a specialist to check that the
 - earthing
 - protective multiple earthing
 - residual-current operated circuit-breaker circuit comply with the safety regulations of the power supply company and work correctly.
- The electrical plug-in connections must be protected from wet conditions.
- If there is a risk of flooding, place the plug-in connections in an area which is safe from flooding.

- Strictly avoid pumping aggressive liquids and abrasive substances.
- Protect the equipment from frost.
- Protect the equipment from dry running.
- Take suitable measures to keep the equipment out of the reach of children.

⚠ CAUTION!

Read all safety regulations and instructions.

Any errors made in following the safety regulations and instructions may result in an electric shock, fire and/or serious injury.

Keep all safety regulations and instructions in a safe place for future use.

2. Layout (Fig. 1)

1. Handle
2. Integrated cable rewind
3. Universal hose connection
4. Intake cage
5. Floating switch
6. Screw for height adjustment

3. Items supplied

- Open the packaging and take out the equipment with care.
- Remove the packaging material and any packaging and/or transportation braces (if available).
- Check to see if all items are supplied.
- Inspect the equipment and accessories for transport damage.
- If possible, please keep the packaging until the end of the guarantee period.

IMPORTANT

The equipment and packaging material are not toys. Do not let children play with plastic bags, foils or small parts. There is a danger of swallowing or suffocating!

- Original operating instructions
- Safety instructions

GB

4. Proper use

The equipment you have purchased is designed to pump water with a maximum temperature of 35 °C. This equipment must never be used for other liquids, especially engine fuels, cleaning agents and other chemically-based products! Installed in a shaft, the equipment provides protection from flooding. However, it can be used wherever you want to move water, e.g. in the house, in the garden, and for many other applications. The equipment must not be used to operate swimming pools!

If you want to use the equipment in bodies of water with a natural, muddy bottom, place the equipment in a slightly elevated position, e.g. on bricks.

The equipment is not designed for continuous operation, e.g. as a circulating pump in a pond. In this case the equipment's anticipated life will be greatly shortened because the equipment was not designed for continuous loading.

The equipment is to be used only for its prescribed purpose. Any other use is deemed to be a case of misuse. The user / operator and not the manufacturer will be liable for any damage or injuries of any kind caused as a result of this.

Please note that our equipment has not been designed for use in commercial, trade or industrial applications. Our warranty will be voided if the machine is used in commercial, trade or industrial businesses or for equivalent purposes.

5. Technical data

Mains connection	240V ~ 50 Hz
Power rating	750 W
Max. pumping rate	16,000 l/h
Max. delivery head	7 m
Max. immersion depth	5 m
Max. water temperature	35 °C
Hose connection	G 1 1/2" female thread
Max. size of foreign bodies:	Ø 25 mm
Switching point height: ON	max. approx. 62 cm
Switching point height: OFF	min. approx. 5 cm

6. Before putting the equipment into operation

6.1 Installation

The equipment can be installed either:

- Stationary with rigid tubing
- or
- Stationary with a flexible hose line

Note:

The maximum pumping rate is possible only with the largest possible line diameter; if smaller hoses or tubes are connected, the pumping rate will be reduced. If the universal hose connection (Fig. 1/Item 3) is used, it should be shortened (as shown in Fig. 4) to the connection actually used in order not to reduce the pumping rate unnecessarily. Flexible hoses must be fastened to the universal hose connection with a hose clip (not included in the scope of supply).

Note!

When installing, never hang the equipment by the discharge line or by the power cable. The equipment must be hung up with the provided carry handle or it must rest on the bottom of the shaft. To ensure that the equipment works properly, the bottom of the shaft always must be free of sludge and other accumulations of dirt. If the water level is too low, the sludge in the shaft can quickly dry out and hinder the equipment from starting. It is necessary therefore to check the equipment regularly (carry out trial start-ups).

Note:

The pump shaft should measure at least 40 x 40 x 50 cm so that the floating switch can move freely.

5.2 Mains connection

The equipment you have purchased comes with an earthing-pin plug. The equipment is designed for connection to a socket outlet with earthing contact for 240 V ~ 50 Hz. Make sure that the socket-outlet is sufficiently fused (at least 6 A) and in good working order. Insert the power plug in the socket-outlet and the equipment is ready for operation.

Important!

To rule out danger, this work must be left strictly to a specialist electrician or Customer Service.

7. Operation

You can put the equipment into operation after you have thoroughly read the installation and operating instructions. Pay attention to the following points:

- Make sure that the equipment is set up securely.
- Check that the discharge line is fitted correctly.
- Make sure that the electrical connection is 240 V ~ 50 Hz.
- Check that the electrical socket-outlet is in good working order.
- Make sure that no moisture or water can ever reach the power connection.
- Make sure that the equipment does not run dry.

Setting the ON/OFF switching point:

The ON/OFF switching point can be infinitely adjusted with the height adjustment facility. For this purpose you must first slacken the screw (Fig. 2, Point 6). The switching differential can be infinitely adjusted by extending or shortening the floating cable.

- The floating switch must be fitted so that the switching point height: ON and the switch point height: OFF can be reached easily and with little force. Check this by placing the equipment in a container filled with water and carefully raising and lowering the floating switch with your hand. You can then see whether the equipment switches on and off.
- Make sure that the distance between the floating switch head and the cable holder is not too small. If the distance is too small, there is no guarantee that the equipment will work correctly.
- When adjusting the floating switch, make sure that the floating switch does not touch the bottom before the equipment is switched off. Important! Risk of dry running.

Manual operation:

Mount the float switch as illustrated in Figure 3 so that the device runs continuously. In this mode the equipment may be used only under supervision to avoid dry running. The equipment must be switched off (pull out the power plug) as soon as no more water is emitted from the discharge line.

8. Replacing the power cable

If the power cable for this equipment is damaged, it must be replaced by the manufacturer or its after-sales service or similarly trained personnel to avoid danger.

9. Cleaning, maintenance and ordering of spare parts

Important!

- Unplug the power plug prior to any maintenance work.
- For mobile applications, the equipment should be cleaned with clear water after every usage.
- For stationary installation, it is recommended that you check the floating switch for proper functioning every three months.
- Use a water jet to remove any lint or fibrous particles that may have become trapped in the housing.
- Remove sludge from the shaft bottom and clean the shaft walls every 3 months.
- Use clear water to remove deposits from the floating switch.

9.1 Cleaning the paddle wheel

If a lot of deposits collect in the housing, the bottom part of the equipment must be dismantled as follows:

1. Disconnect the intake cage from the housing.
2. Clean the paddle wheel with clear water.

Important! Do not put down or rest the equipment on the paddle wheel!
3. Assemble in reverse order.

9.2 Maintenance

There are no parts inside the equipment which require additional maintenance.

9.3 Ordering replacement parts:

Please quote the following data when ordering replacement parts:

- Type of machine
 - Article number of the machine
 - Identification number of the machine
 - Replacement part number of the part required
- For our latest prices and information please go to www.isc-gmbh.info

10. Disposal and recycling

The unit is supplied in packaging to prevent its being damaged in transit. This packaging is raw material and can therefore be reused or can be returned to the raw material system.

The unit and its accessories are made of various types of material, such as metal and plastic. Defective components must be disposed of as special waste. Ask your dealer or your local council.



11. Storage

Store the equipment and accessories out of children's reach in a dark and dry place at above freezing temperature. The ideal storage temperature is between 5 and 30 °C. Store the electric tool in its original packaging.

12. Troubleshooting guide

Faults	Cause	Remedy
The equipment does not start	<ul style="list-style-type: none">- Power supply not connected- Floating switch does trigger	<ul style="list-style-type: none">- Check power supply- Raise position of floating switch
The equipment does not pump	<ul style="list-style-type: none">- Intake sieve clogged- Discharge hose kinked	<ul style="list-style-type: none">- Clean intake sieve with water jet- Unkink the hose
The equipment does not cut out	<ul style="list-style-type: none">- Floating switch cannot sink	<ul style="list-style-type: none">- Place equipment correctly on shaft bottom
Insufficient pumping rate	<ul style="list-style-type: none">- Intake sieve clogged- Performance reduced due to heavily contaminated and abrasive water impurities	<ul style="list-style-type: none">- Clean intake sieve- Clean equipment and replace wear parts
The equipment switches off after briefly running	<ul style="list-style-type: none">- Motor circuit-breaker switches the equipment off due to excessive water contamination- Water temperature too high; motor circuit-breaker switches the equipment off	<ul style="list-style-type: none">- Unplug power plug and clean equipment and shaft- Ensure that maximum permissible water temperature (35 °C) is not exceeded



Ⓢ For EU countries only

Never place any electric tools in your household refuse.

To comply with European Directive 2002/96/EC concerning old electric and electronic equipment and its implementation in national laws, old electric tools have to be separated from other waste and disposed of in an environment-friendly fashion, e.g. by taking to a recycling depot.

Recycling alternative to the demand to return electrical devices:

As an alternative to returning the electrical device, the owner is obliged to cooperate in ensuring that the device is properly recycled if ownership is relinquished. This can also be done by handing over the used device to a returns center, which will dispose of it in accordance with national commercial and industrial waste management legislation. This does not apply to the accessories and auxiliary equipment without any electrical components which are included with the used device.

©
The reprinting or reproduction by any other means, in whole or in part,
of documentation and papers accompanying products is permitted only
with the express consent of ISC GmbH.

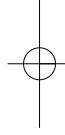
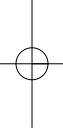

© Technical changes subject to change

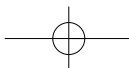

GUARANTEE CERTIFICATE

Dear Customer,

All of our products undergo strict quality checks to ensure that they reach you in perfect condition. In the unlikely event that your device develops a fault, please contact our service department at the address shown on this guarantee card. Of course, if you would prefer to call us then we are also happy to offer our assistance under the service number printed below. Please note the following terms under which guarantee claims can be made:

1. These guarantee terms cover additional guarantee rights and do not affect your statutory warranty rights. We do not charge you for this guarantee.
2. Our guarantee only covers problems caused by material or manufacturing defects, and it is restricted to the rectification of these defects or replacement of the device. Please note that our devices have not been designed for use in commercial, trade or industrial applications. Consequently, the guarantee is invalidated if the equipment is used in commercial, trade or industrial applications or for other equivalent activities. The following are also excluded from our guarantee: compensation for transport damage, damage caused by failure to comply with the installation/assembly instructions or damage caused by unprofessional installation, failure to comply with the operating instructions (e.g. connection to the wrong mains voltage or current type), misuse or inappropriate use (such as overloading of the device or use of non-approved tools or accessories), failure to comply with the maintenance and safety regulations, ingress of foreign bodies into the device (e.g. sand, stones or dust), effects of force or external influences (e.g. damage caused by the device being dropped) and normal wear resulting from proper operation of the device.

The guarantee is rendered null and void if any attempt is made to tamper with the device.
3. The guarantee is valid for a period of 2 years starting from the purchase date of the device. Guarantee claims should be submitted before the end of the guarantee period within two weeks of the defect being noticed. No guarantee claims will be accepted after the end of the guarantee period. The original guarantee period remains applicable to the device even if repairs are carried out or parts are replaced. In such cases, the work performed or parts fitted will not result in an extension of the guarantee period, and no new guarantee will become active for the work performed or parts fitted. This also applies when an on-site service is used.
4. In order to assert your guarantee claim, please send your defective device postage-free to the address shown below. Please enclose either the original or a copy of your sales receipt or another dated proof of purchase. Please keep your sales receipt in a safe place, as it is your proof of purchase. It would help us if you could describe the nature of the problem in as much detail as possible. If the defect is covered by our guarantee then your device will either be repaired immediately and returned to you, or we will send you a new device.

Of course, we are also happy offer a chargeable repair service for any defects which are not covered by the scope of this guarantee or for units which are no longer covered. To take advantage of this service, please send the device to our service address.

EINHELL AUSTRALIA PTY LTD
6/166 Wellington Street
Collingwood VIC 3066
Australia
Phone: 1300 922 271

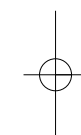
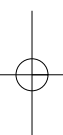

EH 05/2010 (01)

